

Saliscendi | Sliding Rails Art. AST750

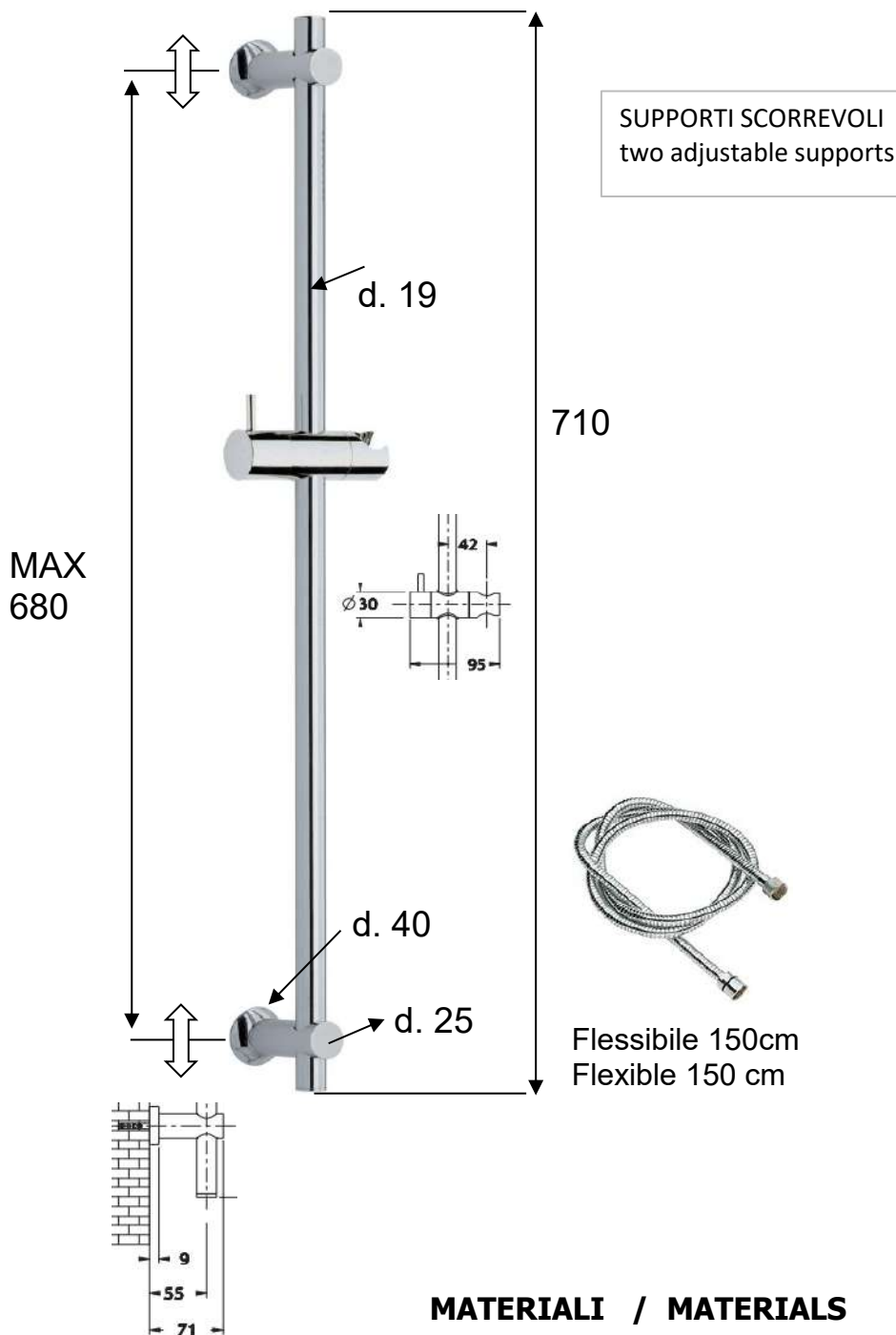

MATERIALI / MATERIALS

OTTONE CROMATO / CHROME PLATED BRASS

CROMATURA / CHROME PLATING

UNI EN 248

Pentagono rubinetterie srl