

# SERIE CROSS



# CROSS

  
**Pentagono**  
RUBINETTERIE



**Art 210Z1000CH1C**

Rubinetto incasso 1/2  
con vitone

*Built-in stop cock with  
normal valve 1/2*

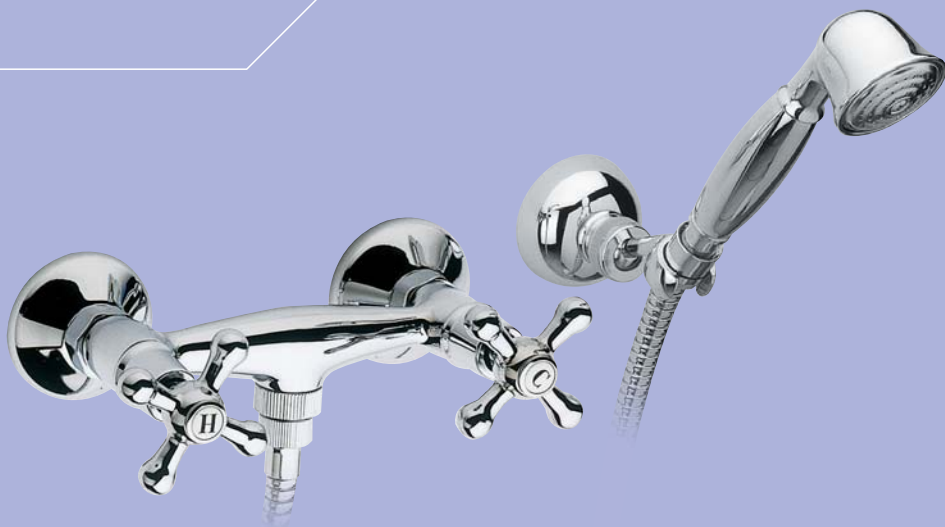

**Art 210Z1002CH1C**

Gruppo doccia esterno

*External shower mixer  
with handshower set*

**Art 210Z1003CH1C**

Gruppo doccia esterno  
senza kit doccia

*External shower mixer  
without handshower set*



**Art 210Z2002CH1C**

Gruppo vasca attacco 3/4

*Bathtub unit with 3/4 connection*

## SERIE CROSS



Art 210Z2000CH1C

Gruppo vasca con doccia duplex

*Bathtub unit with handshower set*



Art 210Z3000CH1C (1")  
Art 210Z3001CH1C (1"1/4)

Batteria lavabo con scarico automatico 1" - 1"1/4

*Basin mixer set with automatic pop-up waste 1" - 1"1/4*



Art 210Z3010CH1C (1")  
Art 210Z3011CH1C (1"1/4)

Batteria lavabo con scarico automatico 1" - 1"1/4

*Basin mixer set with automatic pop-up waste 1" - 1"1/4*



**Art** 210Z3020CH1B (1")  
**Art** 210Z3021CH1B (1"1/4)

Monoforo lavabo con scarico automatico 1" - 1"1/4

*One-hole basin mixer set with automatic pop-up waste 1" - 1"1/4*



**Art** 210Z3030CH1C

Rubinetto lavabo da 1/2

*Basin tap 1/2*



**Art** 210Z4020CH1B (1")  
**Art** 210Z4021CH1B (1"1/4)

Monoforo bidet con scarico automatico 1" - 1"1/4

*One-hole bidet mixer with automatic pop-up waste 1" - 1"1/4*



**Art** 210Z5000CH1C

Gruppo lavello a muro

*Sink mixer wall mounted*



**Art** 210Z5005CH1C

Rubinetto singolo lavello bocca girevole

*Sink tap wall mounted and swivel spout*

**Art** 210Z5002CH1C

Gruppo lavello a muro canna "U"

*Sink mixer wall mounted "U" spout*

**Art** 210Z5006CH1C

Rubinetto singolo lavello bocca girevole canna "U"

*Sink tap wall mounted and swivel "U" spout*



Art 210Z4000CH1C (1")  
Art 210Z4001CH1C (1"1/4)

Batteria bidet con scarico automatico 1" - 1"1/4

*Bidet mixer set with automatic pop-up waste 1" - 1"1/4*



Art 210Z4003CH1C (1")  
Art 210Z4004CH1C (1"1/4)

Batteria bidet con doccetta scarico automatico 1" - 1"1/4

*Bidet mixer set with shower and automatic pop-up waste 1" - 1"1/4*



Art 210Z6000CH1B

Gruppo lavello monoforo canna ponte

*One-hole sink mixer with swivel spout*



Art 210Z6003CH1B

Gruppo lavello monoforo canna tipo fusa

*One-hole sink mixer with swivel spout heavy type*

# SERIE CROSS

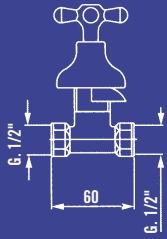

Art. 210Z1000CH1C

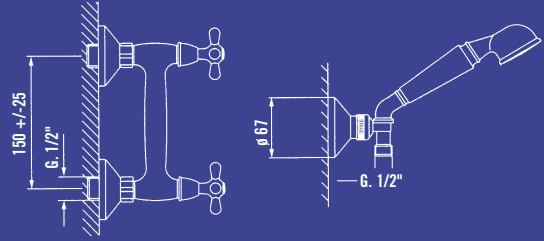

Art. 210Z1002CH1C

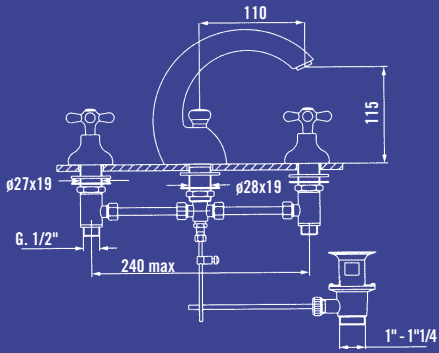

Art. 210Z3011CH1C

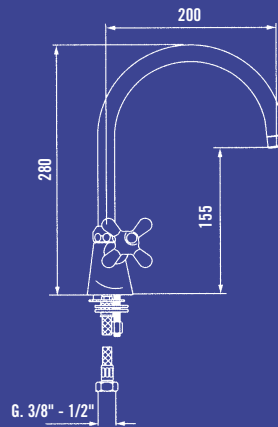

Art. 210Z6000CH1B

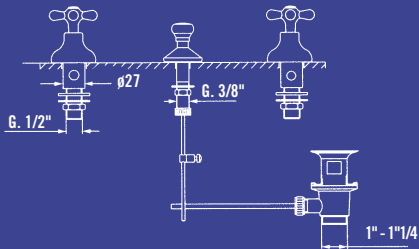

Art. 210Z4001CH1C

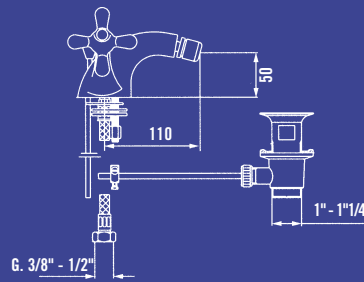

Art. 210Z4021CH1B

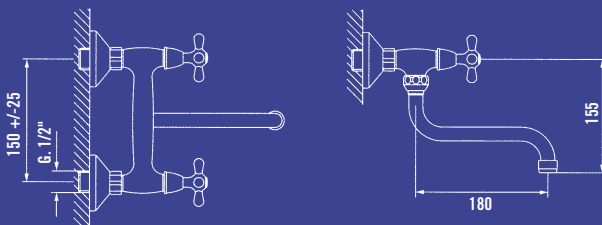

Art. 210Z5000CH1C

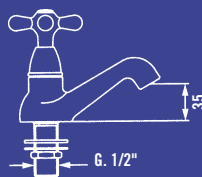

Art. 210Z3030CH1C